

Dacatie Green Building Solutions - Product Drawing

Quantum Profile Systems Ltd.

Salmon Fields, Royton, Oldham, Lancashire. OL2 6JG.

Tel: 0161 627 4222 Fax: 0161 627 4333 email: info@quantum-ps.co.uk

DACATIE

GREEN BUILDING SOLUTIONS

CTF1000 available in 5mm intervals from 50mm - 100mm

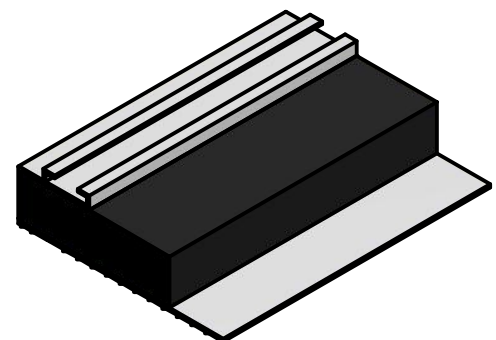
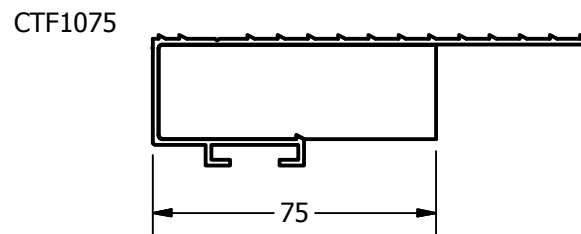
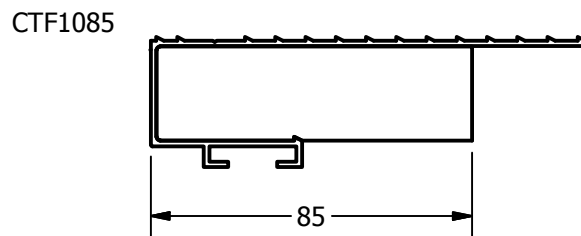
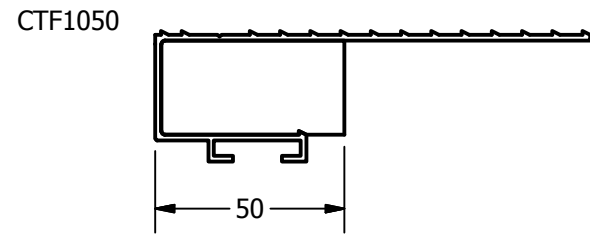
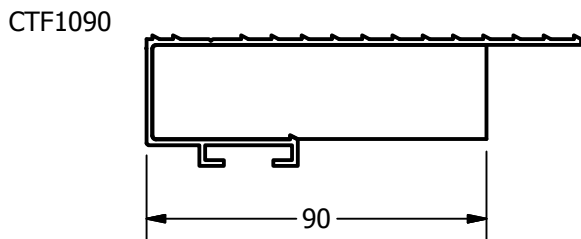
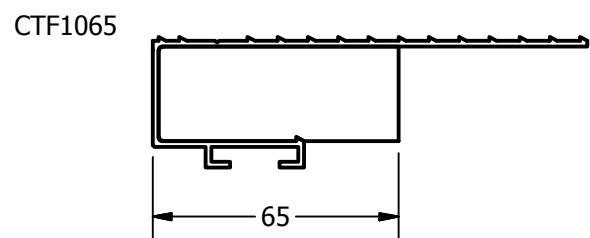
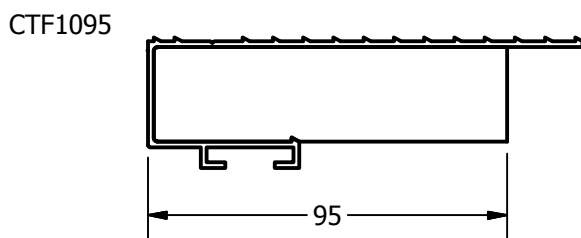
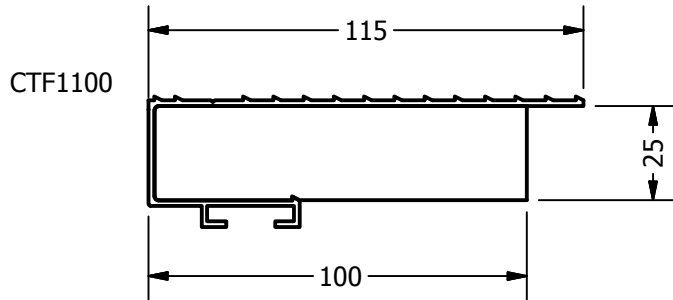

This CAD drawing (electronic or paper format) and the copyright thereon are the property of Quantum Profile System Ltd

Product: CTF1000

Scale: 2:1

Material: UPVC & XPS Insulation

Dimensions shown are nominal. Product subject to minor design alterations without notice. For more information please call 0161 627 4222 or CustomerService@quantum-ps.co.uk

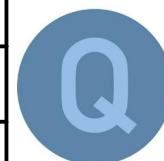

QPSL